

SPECIFICATIONS

Loudspeaker Type:	Two-way, compact column array loudspeaker, 8 ohm or 70V/100V operation
Operating Range:	120 Hz to 22 kHz (-10 dB)
Frequency Response:	180 Hz to 20 kHz (-3 dB)
Max Input Ratings (8 ohm):	150W continuous, 300W program 35 volts RMS, 69 volts momentary peak
Autoformer Taps—70V:	60W, 30W, 15W, 7.5W, 3.75W
100V:	60W, 30W, 15W, 7.5W
Sensitivity (1W/1m):	93dB (180 Hz - 20 kHz)
Maximum Output:	115 dB SPL / 121 dB SPL (peak)
Nominal Impedance:	8 ohms
Minimum Impedance:	8.1 ohms @ 12500 Hz
Vertical Coverage:	20° (2 kHz to 16 kHz ±10°) @ 13m
Horizontal Coverage:	140° average (1 kHz - 10 kHz ±20°)
Crossover Frequency:	5000 Hz
Recommended Signal Processing:	120 Hz, 24 dB/Oct high pass filter
Drivers:	LF 6 x 80mm long excursion mylar driver HF 2 x 3-element Compact Ribbon Emulator
Driver Protection:	Dynamic protection circuitry
Input Connection:	NL4 Speakon-type connector for low impedance operation; and 8-position terminal strip for low impedance or constant voltage operation
Controls:	None
Enclosure:	Extruded, high gloss paintable PVC
Finish:	Black or white
Grille:	Powder-coated aluminum, black or white finish
Safety Features:	Built-in safety eyebolt
Environmental:	Outdoor Direct Exposure Certified IP54W per IEC529 for UV, moisture and salt spray
Required Accessories:	High pass filter
Supplied Accessories:	Pan-tilt bracket accommodating zero to 22.5° down-tilt and +/- 55° panning; and ABS plastic rain cover with integrated cable inlet and 1" (25.4mm) knockout for conduit ingress
Optional Accessories:	E200-UMK universal mounting kit E200-SAK stand adapter kit
Dimensions—Height:	19.9 inches (506 mm)
Width:	4.62 inches (117 mm)
Depth:	7.47 inches (189 mm)
Weight (without bracket):	15 lbs (6.8 kg)
Shipping Weight:	17.3 lbs (7.8 kg)

NOTES:

- Sensitivity: Free field pink noise measurement at 6ft (1.8m) at 10% power; extrapolated to 1 meter and an input of 2.83 volts RMS.
- Watts: All wattage figures are calculated using the rated nominal impedance.

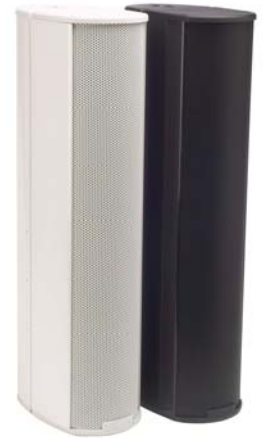

APPLICATIONS

- Houses of worship
- Bars and restaurants
- Meeting rooms, conference rooms, court rooms
- Auditoria, live theaters, museums
- Airports, train stations
- Stadium concourses
- Multipurpose outdoor and indoor venues
- Delay fill in larger venues

FEATURES

- Advanced passive crossover technology
- Dynamic protection circuitry
- Compact Ribbon Emulator high frequency technology for narrow, well-behaved vertical directivity control
- All-weather construction for indoor/outdoor usage
- Selectable low impedance or 70V/100V operation
- Simple installation using the included pan-tilt mounting bracket
- Tightly controlled vertical dispersion reduces harmful room reflections
- Wide horizontal dispersion means fewer units cover a given area
- Clean, clear and powerful sonic output without the cost of bi-amplification
- Available in standard black or white finishes, may also be painted to match room décor

DESCRIPTION

The ENT206 is an all-weather, column array loudspeaker housed in an attractive, heavy duty extruded PVC enclosure. Double the height of the smaller ENT203, the ENT206 provides directional control at significantly lower frequencies than the ENT203, along with enough power to effectively cover much larger areas while still remaining unobtrusive. Ideally suited to applications such as music and speech reinforcement for reverberant houses of worship, hotel lobbies, assembly rooms, transit stations, indoor/outdoor swimming pools, outdoor smoking areas, bowling alleys, and much more, the ENT206 is a solid performer that belies its small size. Like the ENT203, the ENT206 also can be utilized to support larger systems for delay and area fill. The ENT206 employs six high-power LF cone drivers and two Community CRE (Compact Ribbon Emulator) HF tweeter arrays in a two-way, single-amped configuration.

ENT206

TWO-WAY, COMPACT
COLUMN ARRAY LOUDSPEAKER

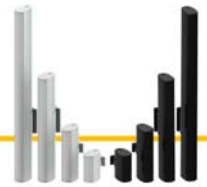

FREQUENCY RESPONSE

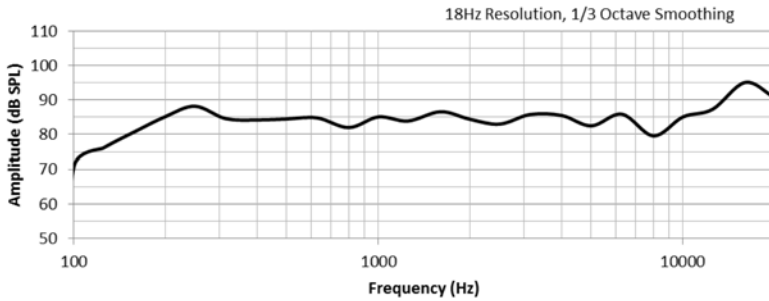

IMPEDANCE

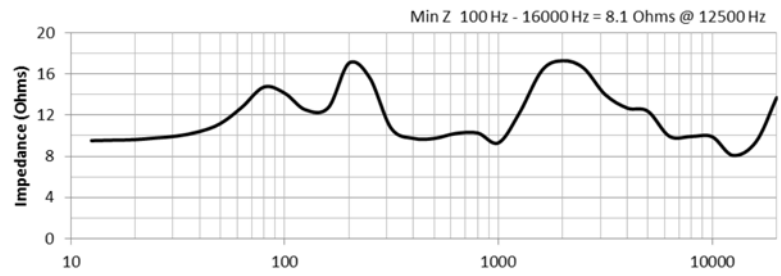

BEAMWIDTH

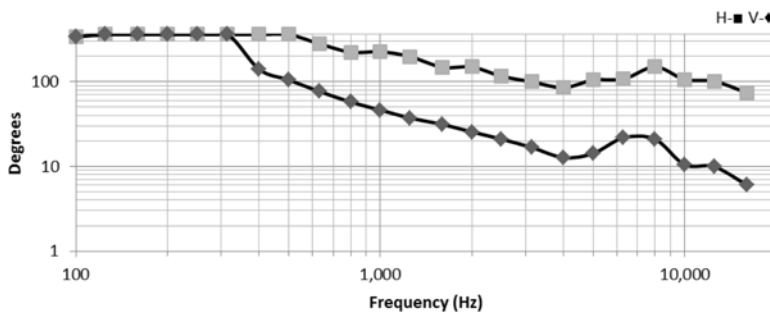

AXIAL Q

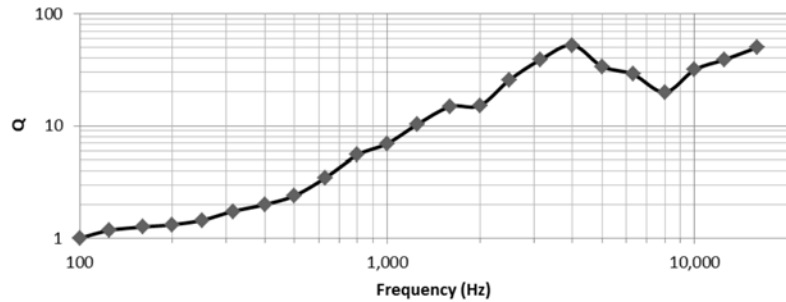

DIMENSIONS

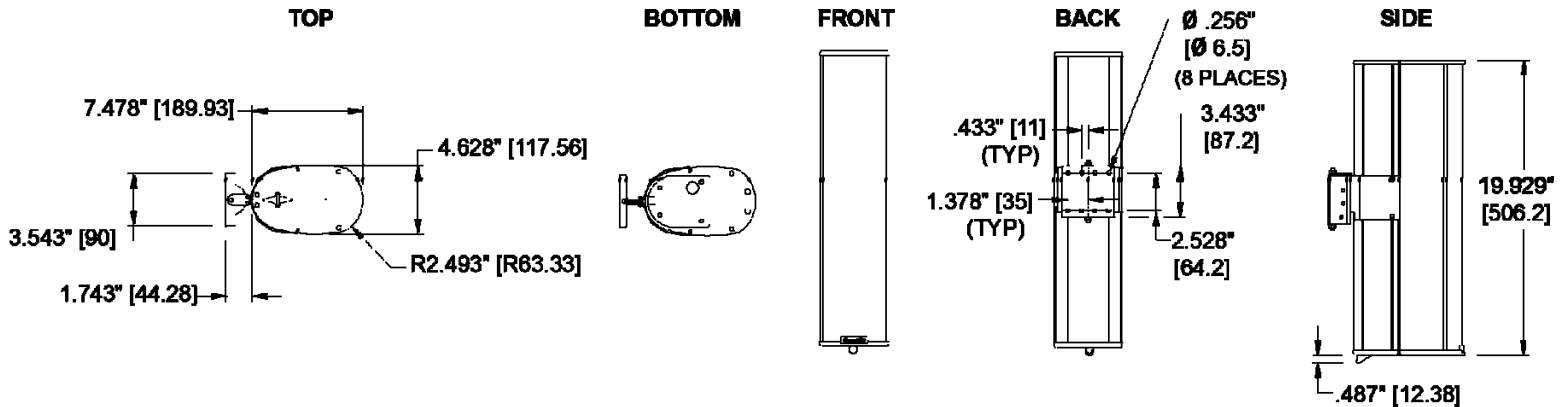

ARCHITECTURAL SPECIFICATIONS

The loudspeaker system shall be a two-way, full-range compact column array system with six 80mm long excursion mylar low frequency transducers and two three-element Compact Ribbon Emulator direct-radiating high frequency transducers. The drivers shall be connected to an integral crossover with an HF crossover frequency of 5000 Hz, with dynamic driver protection circuitry. The paintable enclosure shall be constructed of high-gloss PVC. The system shall have a frequency response of 180 Hz to 20 kHz (-3 dB) and a low impedance (8 ohm) input capability of 35V RMS. The sensitivity at 1W/1m shall be 93 dB (180 Hz to 20 kHz). The loudspeaker system shall have a vertical coverage of 20° (2 kHz - 16 kHz ±10°) @ 13m and a horizontal coverage of 140° average (1 kHz - 10 kHz ±20°). The system shall be equipped with a 60W high performance autoformer for use in 70.7V or 100V distributed audio systems, with 60W, 30W, 15W, 7.5W and 3.75W taps available in 70.7V distributed systems (60W, 30W, 15W and 7.5W taps available in 100V distributed systems). Dimensions shall be 19.9 inches (506 mm) high, 4.62 inches (117 mm) wide and 7.47 inches (189 mm) deep, with a loudspeaker weight of 15 lbs (6.8 kg).

Community strives to improve its products on a continual basis. Specifications are therefore subject to change without notice.