

SPECIFICATIONS

Loudspeaker Type:	Two-way, column array loudspeaker, 8 ohm or 70V/100V operation
Operating Range:	100 Hz to 22 kHz (-10 dB)
Frequency Response:	160 Hz to 20 kHz (-3 dB)
Max Input Ratings (8 ohm):	325W continuous, 650W program 51 volts RMS, 102 volts momentary peak
Autoformer Taps—70V:	120W, 60W, 30W, 15W, 7.5W
100V:	120W, 60W, 30W, 15W
Sensitivity (1W/1m):	96 dB (160 Hz - 20 kHz) full space
Maximum Output:	121 dB SPL / 127 dB SPL (peak)
Nominal Impedance:	8 ohms
Minimum Impedance:	8.5 ohms @ 400 Hz
Vertical Coverage:	15° (2 kHz - 16 kHz \pm 15°) @ 13m
Horizontal Coverage:	140° average (1 kHz - 10 kHz \pm 20°)
Crossover Frequency:	5000 Hz
Recommended Signal Processing:	100 Hz, 24 dB/Oct high pass filter
Drivers:	LF 12 x 80mm long excursion mylar driver HF 4 x 3-element Compact Ribbon Emulator
Driver Protection:	Dynamic protection circuitry
Input Connection:	NL4 Speakon-type connector for low impedance operation; and 8-position terminal strip for low impedance or constant voltage operation
Controls:	None
Enclosure:	Extruded, high gloss paintable PVC
Finish:	Black or white
Grille:	Dual-layer powder coated steel, black or white finish
Safety Features:	Built-in safety eyebolt
Environmental:	Outdoor Direct Exposure Certified IP54W per IEC529 for UV, moisture and salt spray
Required Accessories:	High pass filter
Supplied Accessories:	Pan-tilt bracket accommodating zero to 9° down-tilt and \pm 55° panning; and ABS plastic rain cover with integrated cable inlet and 1" (25.4mm) knockout for conduit ingress
Optional Accessories:	E200-UMK universal mounting kit E200-SAK stand adapter kit
Dimensions—Height:	39.1 inches (993 mm)
Width:	4.62 inches (117 mm)
Depth:	7.47 inches (189 mm)
Weight (without bracket):	28 lbs (12.7 kg)
Shipping Weight:	33 lbs (15 kg)



APPLICATIONS

- Houses of worship
- Bars and restaurants
- Meeting rooms, conference rooms, court rooms
- Auditoria, live theaters, museums
- Airports, train stations
- Stadium concourses
- Gymnasiums, athletic facilities
- Multipurpose outdoor and indoor venues

FEATURES

- Advanced passive crossover technology
- Dynamic protection circuitry
- Compact Ribbon Emulator high frequency technology for narrow, well-behaved vertical directivity control
- All-weather construction for indoor/outdoor usage
- Selectable low impedance or 70V/100V operation
- Simple installation using the included pan-tilt mounting bracket
- Tightly controlled vertical dispersion reduces harmful room reflections
- Wide horizontal dispersion means fewer units cover a given area
- Clean, clear and powerful sonic output without the cost of bi-amplification
- Available in standard black or white finishes, may also be painted to match room décor

DESCRIPTION

The ENT212 is an all-weather column line array housed in an attractive, heavy duty extruded PVC enclosure. Twice the height of the ENT206, the ENT212 provides vertical directional control at far lower frequencies than the ENT206, plus enough power to cover medium-sized venues as the primary system. The ENT212 excels in noisy environments - gymnasiums and other athletic venues are just two of many examples - while its high-fidelity response makes it suitable for more subtle applications such as scholastic auditoriums, houses of worship, jazz and folk music clubs, corporate AV presentations, and much more. The excellent vertical directivity conquers large, reverberant spaces, providing excellent intelligibility and musicality. With the addition of subwoofers, an ENT212 system is capable of meeting a vast range of requirements, from the soccer stadium to the performing arts center. The ENT212 employs twelve high-power LF cone drivers and four Community CRE (Compact Ribbon Emulator) HF tweeter arrays in a single-amped configuration that employs a 4-way frequency shaded crossover.

NOTES:

1. Sensitivity: Free field pink noise measurement at 6ft (1.8m) at 10% power; extrapolated to 1 meter and an input of 2.83 volts RMS.
2. Watts: All wattage figures are calculated using the rated nominal impedance.

ENT212

TWO-WAY, COMPACT COLUMN ARRAY LOUDSPEAKER

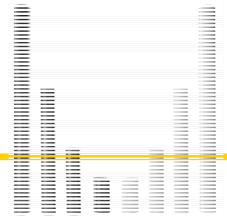

FREQUENCY RESPONSE

18Hz Resolution, 1/3 Octave Smoothing

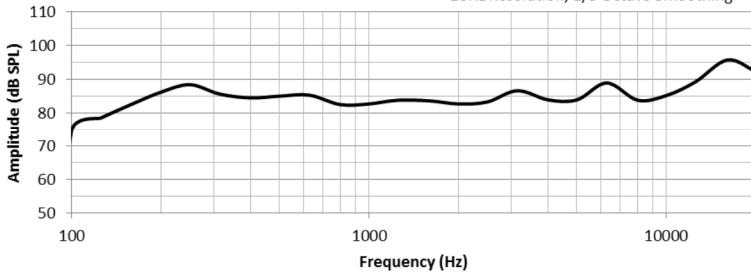

IMPEDANCE

Min Z 100 Hz - 16000 Hz = 8.5 Ohms @ 400 Hz

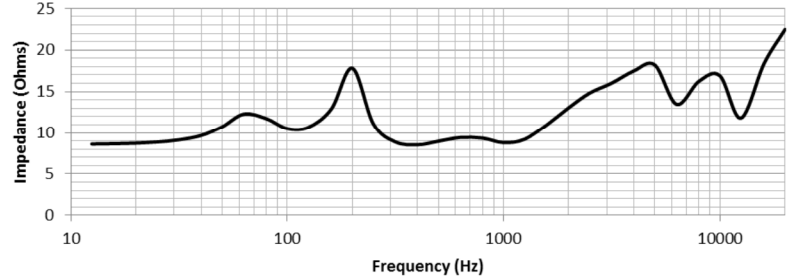

BEAMWIDTH

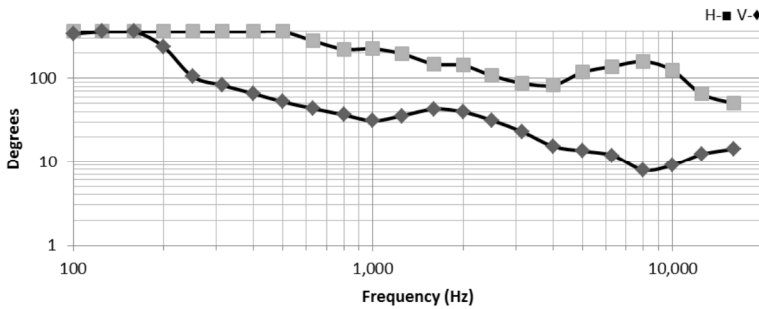

AXIAL Q

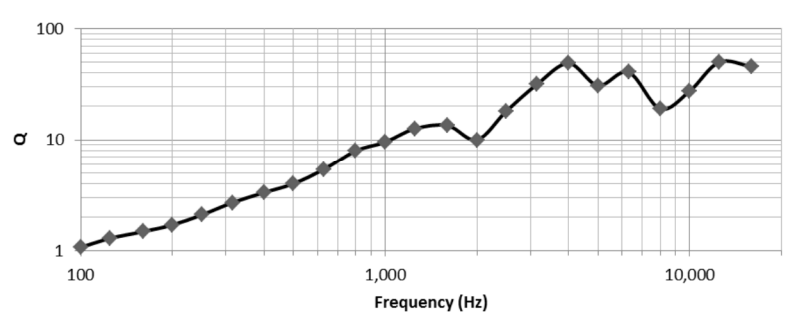

DIMENSIONS

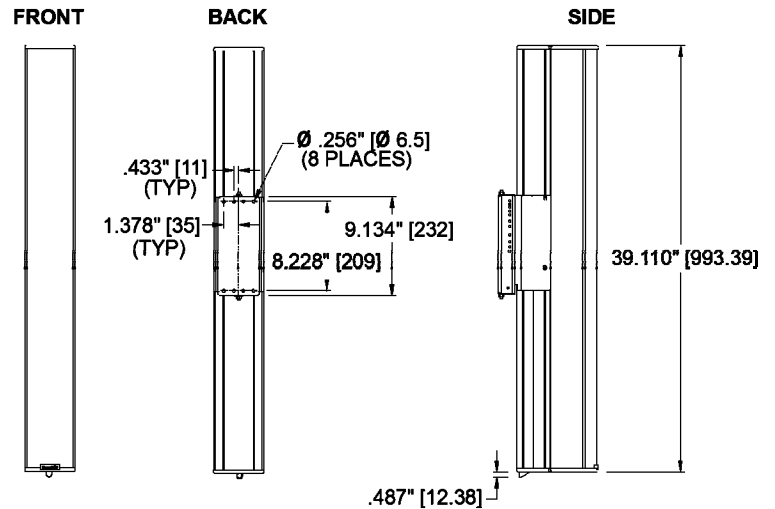
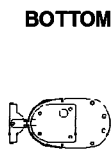
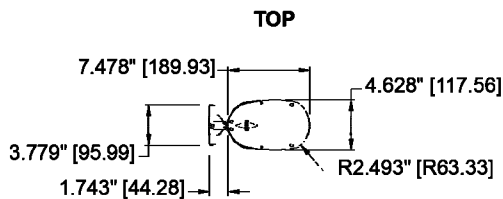

ARCHITECTURAL SPECIFICATIONS

The loudspeaker system shall be a two-way, full-range column array system with twelve 80mm long excursion mylar low frequency transducers and four three-element Compact Ribbon Emulator direct-radiating high frequency transducers. The drivers shall be connected to an integral crossover employing 4-way frequency shaded circuitry, and an HF crossover frequency of 5000 Hz, with dynamic driver protection circuitry. The paintable enclosure shall be constructed of high-gloss PVC. The system shall have a frequency response of 160 Hz to 20 kHz (-3 dB) and a low impedance (8 ohm) input capability of 51V RMS. The sensitivity at 1W/1m shall be 96 dB (160 Hz to 20 kHz). The loudspeaker system shall have a vertical coverage of 15° (2 kHz - 16 kHz ±10°) @ 13m and a horizontal coverage of 140° average (1 kHz - 10 kHz ±20°). The system shall be equipped with a 120W high performance autoformer for use in 70.7V or 100V distributed audio systems, with 120W, 60W, 30W, 15W and 7.5W taps available in 70.7V distributed systems (120W, 60W, 30W and 15W taps available in 100V distributed systems). Dimensions shall be 39.1 inches (993 mm) high, 4.62 inches (117mm) wide and 7.47 inches (189mm) deep, with a loudspeaker weight of 28 lbs (12.7 kg).

Community strives to improve its products on a continual basis. Specifications are therefore subject to change without notice.