

SPECIFICATIONS

Loudspeaker Type:	2-way, horn loaded coaxial, weather-resistant
Operating Range:	85 Hz to 16 kHz 125 Hz to 10 kHz (± 4 dB)
Max Input Ratings:	200W, 70V/100V
Recommended Power Amplifier:	25W to 200W @ 70 Volts 50W to 200W @ 100 Volts
Sensitivity (1W/1m):	102 dB SPL (125 Hz to 10 kHz 1/3 octave bands) 102 dB SPL (250 Hz to 4 kHz speech range)
Maximum Output on 200W Tap:	125 dB SPL
200W Nominal Impedance:	25 ohms
200W Minimum Impedance:	16.4 ohms @ 9.3 kHz
Nominal -6dB Beamwidth:	60° H (+3° / -8°, 1.6 kHz to 12.5 kHz) 60° V (+20° / -16°, 1.6 kHz to 12.5 kHz)
Axial Q / DI:	21.4 / 13.3, 1.6 kHz to 12.5 kHz
Crossover Frequency:	2 kHz
Recommended Signal Processing:	90 Hz high pass filter
Drivers:	LF (1) 12" Ferrofluid-cooled HF (1) 1" exit, titanium free, Ferrofluid-cooled
Driver Protection:	DYNA-TECH
Input Connection:	12 foot (4 m) SJOW #16 gauge
Controls:	4 position autoformer TAP select switch 70V switchable taps @ 200W, 100W, 50W, 25W 100V switchable taps @ 200W, 100W, 50W
Enclosure:	Rotomolded LLDPE, light grey
Mounting/Rigging Provisions:	(5) 3/8-16 rigging points
Grille:	3-layer WeatherStop™, light grey (Zinc-rich epoxy dual-layer powder coated perforated steel grille, foam, woven poly mesh)
Environmental Performance:	IEC529 IP55W rating with a minimum 5-degree downward aiming angle
Required Accessories:	24 dB/Oct high pass filter
Supplied Accessories:	(1) Yoke bracket, light grey (1) Aiming strap
Optional Accessories:	PMB Series pole mount brackets
Dimensions—Height:	16 inches (406.4 mm)
Width:	16 inches (406.4 mm)
Depth:	15.94 inches (404.88 mm)
Weight:	37 lbs (16.8 kg)
Shipping Weight:	42 lbs (19.1 kg)



APPLICATIONS

- Fill speaker for stadia, athletic fields, arenas and race tracks
- Convention centers
- Outdoor background music / paging systems
- Theme and amusement parks
- Fairgrounds, rodeos, air shows
- Malls, cruise ships, skating rinks
- Swimming pools
- Portable sound systems

FEATURES

- Weather-resistant, rotomolded UV enclosure
- Weather-treated drivers and crossovers
- Corrosion-resistant zinc-rich epoxy dual-layer powder coated steel grille and yoke
- Pattern control down to 630 Hz
- High efficiency
- Integral mounting points
- High power passive crossover
- DYNA-TECH protection circuitry
- Multi-tap 200W autoformer for 70V and 100V inputs

DESCRIPTION

The R.5-66TZ two-way, full-range loudspeaker system is engineered to provide quality full-range sound projection in a variety of outdoor and indoor applications. Its wide range, smooth frequency response and high efficiency ensure both high fidelity music reproduction and superb projection of clear intelligible speech with very low distortion. An input autoformer with switchable taps provides impedance matching to 70V or 100V lines. Five-year limited product warranty; fifteen-year enclosure warranty.

NOTES:

1. Sensitivity: Free field pink noise measurement at 35 ft (10.7 m) at 75% power; extrapolated to 1 meter and an input of 2.83 volts RMS.
2. Watts: All wattage figures are calculated using the rated nominal impedance.

FREQUENCY RESPONSE

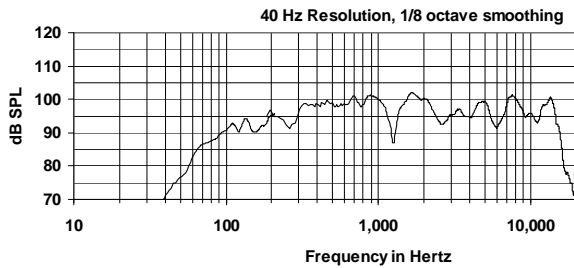

200W IMPEDANCE

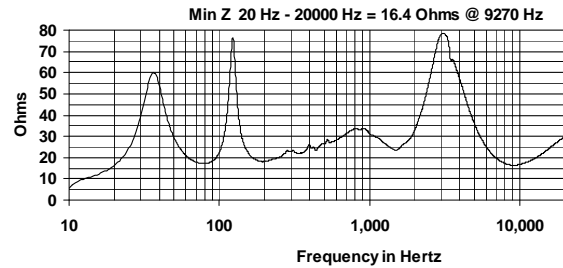

BEAMWIDTH

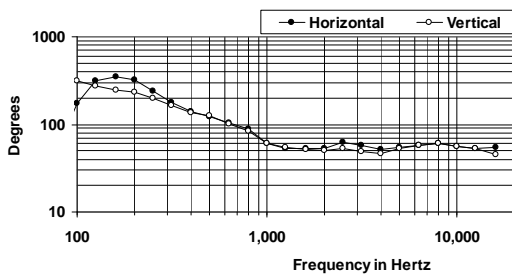

AXIAL Q

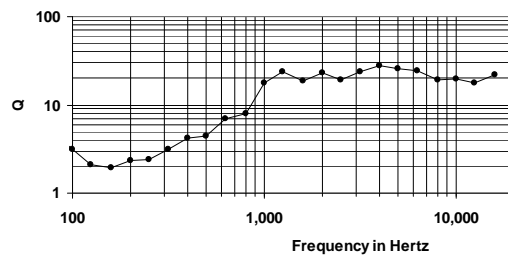

DIMENSIONS

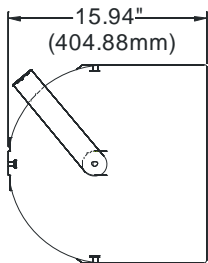

SIDE VIEW

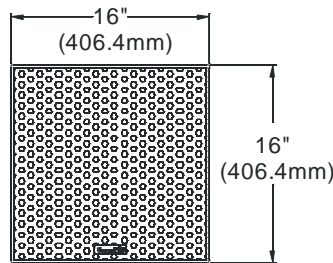

FRONT VIEW

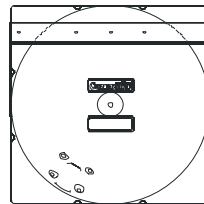

REAR VIEW

R.5 YOKE

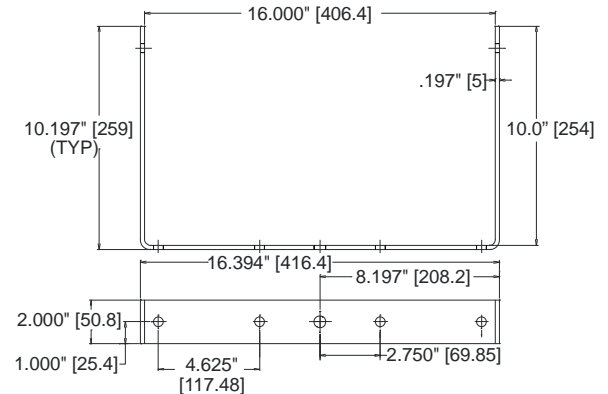

ARCHITECTURAL SPECIFICATIONS

The loudspeaker system shall be a horn-loaded, two-way, coaxial design consisting of one 12" Ferrofluid-cooled driver and one 1" exit, titanium free, Ferrofluid-cooled compression driver mounted on a horn inside the cabinet. The drivers shall be connected to a passive crossover network with a crossover frequency at 2 kHz with driver protection using DYNA-TECH protection circuitry. The cabinet shall be a rotomolded linear low density polyethylene enclosure providing weather and UV resistance with a three-layer weather resistant grille. The steel grille shall be powder coated with a proprietary zinc-rich epoxy dual-layer powder coating process in light grey to color match the enclosure. The system shall have an IEC529 IP rating of IP55W with a minimum 5-degree downward aiming angle. The input connection shall be one 12' (4m) SJOW #16 gauge cable with stripped ends. The enclosure shall incorporate five 3/8-16 rigging points for multiple mounting options. In addition, the loudspeaker will be supplied with one zinc-rich epoxy dual-layer powder coated steel yoke bracket and one multi-tap autoformer for 70V and 100V inputs. The loudspeaker system shall have an amplitude response of 125Hz to 10 kHz (+/- 4 dB SPL), an input capacity of 200W (70V/100V), 102 dB SPL sensitivity @ 2.83V / 1 meter between 250 Hz to 4 kHz at a nominal 8 ohm impedance. The nominal dispersion shall be 60° x 60° over a frequency range of 1.6 kHz to 12.5 kHz. The dimensions of the enclosure are defined as 16" x 16" x 15.94" (HWD) at a weight of 37 lbs.

Community strives to improve its products on a continual basis. Specifications are therefore subject to change without notice.